

catch  
**BOX**

2.4

## **User's Manual**

Copyright 2014 Trick Technologies Oy

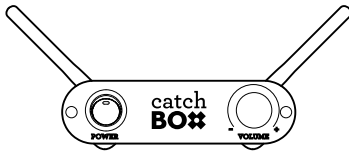

Catchbox 2.4  
Receiver

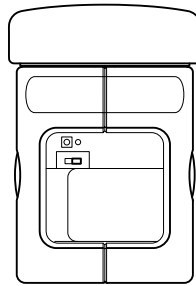

Catchbox 2.4  
Transmitter

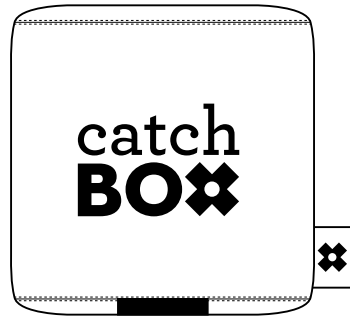

Catchbox 2.4  
Cover

# Contents

---

|   |    |
|---|----|
| <b>1 Safety Instructions</b> .....                | 4  |
| <b>2 Quick Start</b> .....                        | 6  |
| Setting Up the Catchbox .....                     | 6  |
| Using the Catchbox .....                          | 12 |
| <b>3 Product Description</b> .....                | 14 |
| Overview .....                                    | 14 |
| Proper Use and Working Environment .....          | 15 |
| 2.4 GHz radio Spectrum Overview .....             | 16 |
| <b>4 System Overview</b> .....                    | 17 |
| Catchbox 2.4 Receiver.....                        | 18 |
| Catchbox 2.4 Transmitter.....                     | 19 |
| Catchbox Cover .....                              | 20 |
| Catchbox 2.4 Microphone.....                      | 21 |
| <b>5 Operations</b> .....                         | 22 |
| Attaching the Antennas to the Receiver .....      | 22 |
| Receiver Setup .....                              | 22 |
| Turning the Device on .....                       | 23 |
| Adjusting Volume.....                             | 24 |
| Locking the Transmitter to the Cover.....         | 25 |
| Opening the Catchbox .....                        | 26 |
| Pairing the Transmitter and the Receiver .....    | 27 |
| Connecting to an audio device .....               | 28 |
| <b>7 Troubleshooting</b> .....                    | 29 |
| <b>8 Maintenance, Storage, and Disposal</b> ..... | 30 |
| <b>9 Certification</b> .....                      | 31 |

# 1 Safety Instructions

---

## ! NOTICE !



- Before using the product, read and understand the user manual and inform others of proper usage.
- Follow all warnings and instructions on the product and in this manual.
- Keep these instructions and always include these instructions when passing the apparatus on to third parties.

## ! WARNING !



- Not heeding these warnings might lead to serious injury or property damage.
- Do not throw at peoples' heads and always make sure everyone is aware of the situation before throwing.
- Do not use in situations with fragile objects, hot liquids, or people susceptible to injury, like the very young or old.
- Do not throw long passes (>5 m / 16 ft) or hard passes overhead.
- Properly lock the transmitter into the cover before use. Always use the cover and the foam cap on the transmitter, when using the product.
- Do not swing or throw the product from its handle. This may cause the transmitter to detach from the cover and cause injury.
- Operating or storing this product at temperatures above 50 degrees Celsius or 122 degrees Fahrenheit will cause the locking mechanism to fail permanently.
- The use of other antennas than those provided by the manufacturer is strictly prohibited.
- This product contains magnets which could affect the functioning of pacemakers and other electronic implants. These could stop working or switch into test mode, causing illness. If you wear these devices keep sufficient distance to magnets. Warn others who wear these devices from getting too close to magnets.

## ! CAUTION !



- Magnets produce a far-reaching, strong magnetic field. Keep magnets away from devices and objects that could be damaged by strong magnetic fields, like laptops and other electrical equipment.
- Do not place the product near heat sources such as heating ducts or radiators and do not expose it to direct sunlight, excessive dust, moisture, rain, mechanical vibrations or shock.
- Do not use near water. Use equipment indoors only. If the equipment comes into contact with a liquid, turn off the product, shut down the sound system and disconnect the power cable from the power outlet immediately.
- Avoid excessive volume. Do not exceed 70dBa for airborne noise.
- Operate the equipment only with the included power supply.
- Clean the equipment with a moistened (not wet) cloth only. Be sure to disconnect the equipment from the power outlet before cleaning the equipment. Unplug the apparatus during lightning storms or when not in use.
- Protect the power supply cord from being walked on or pinched.
- The equipment should be opened, serviced, and repaired by qualified service personnel only.
- Do not attempt to modify this product or its accessories and use only accessories and attachments, like antennas and power supply, specified by the manufacturer.
- Changes or modifications to the equipment not expressly approved by manufacturer can void the user's authority to operate the equipment.
- Use only AA (LR6) type alkaline batteries with the product.
- Be sure to dispose of dead batteries as required by local waste disposal rules. Never throw batteries into a fire or a garbage bin.

## 2 Quick Start

---

### Setting up the Catchbox

---

Before use, review the important safety instructions. To reduce setup time, each Catchbox 2.4 Receiver and Catchbox 2.4 Transmitter unit have been paired before being shipped. Remember that the Catchbox 2.4 system is designed for audiences of 100 or less, and has a maximum range of 30m.

#### 1.

Connect the two antennas to the receiver unit by screwing them clockwise and arranging them in a V shape.

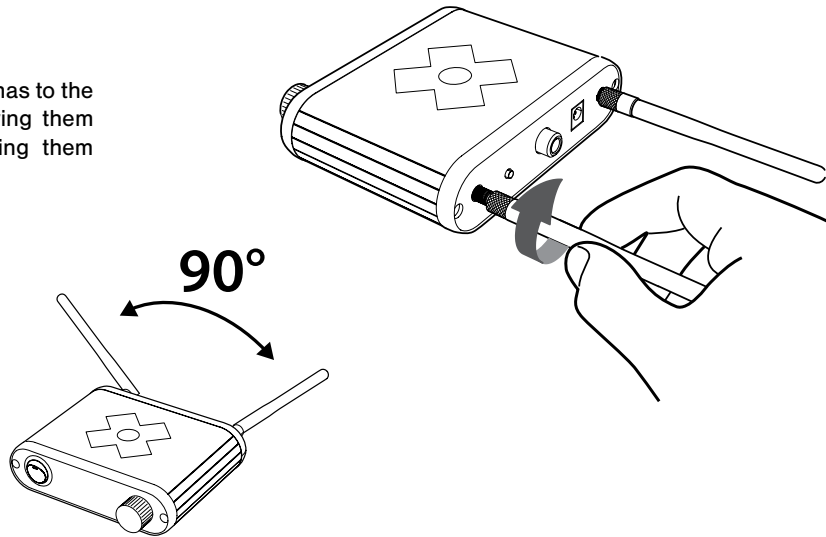

**! WARNING !**

The use of other antennas than those provided by the manufacturer is strictly prohibited.

## 2.

Connect the power supply to the receiver and plug the cord into an AC power source. Connect the audio output to a sound mixer or other audio device such as a stereo system. Use included adapters to match the audio input of the given device.

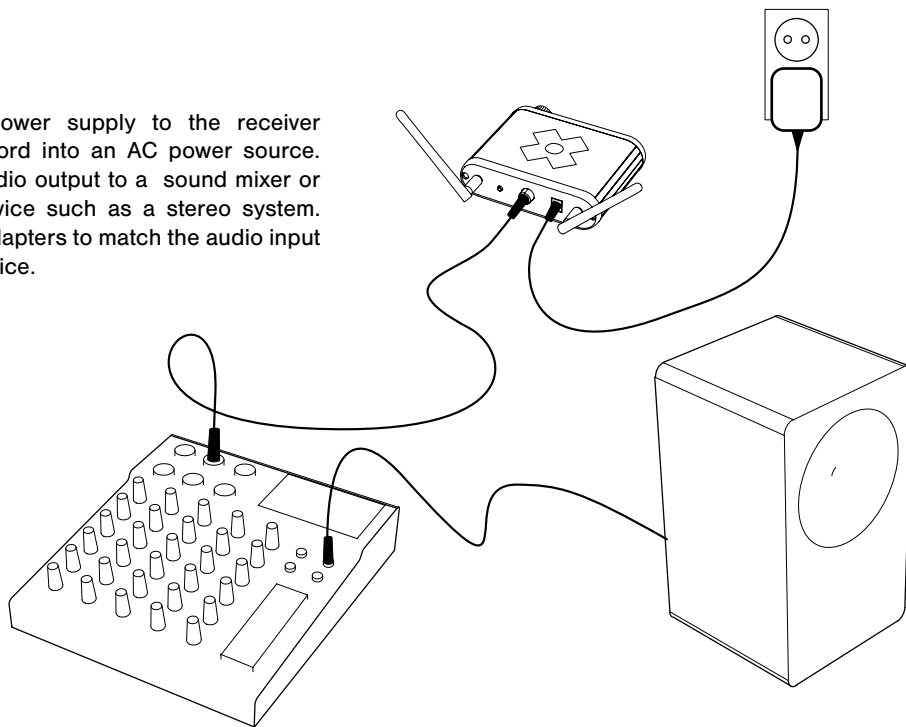

### 3.

Remove the transmitter from the outer cover by twisting the cylinder 90 degrees and pulling upwards.

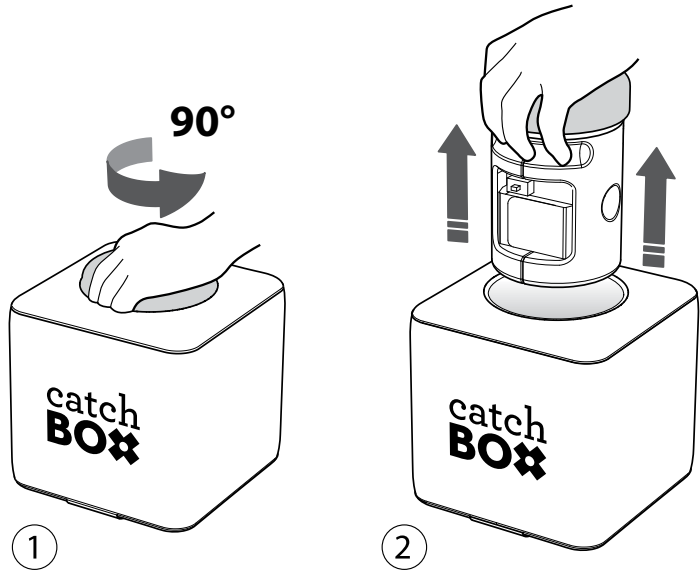

### 4.

Install two AA batteries into the transmitter and secure them in place with the velcro strap.

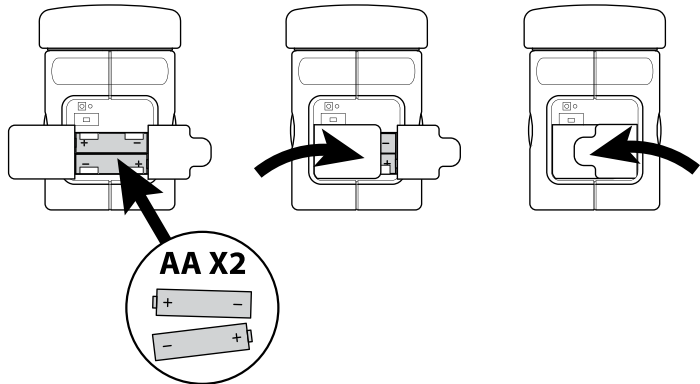



## 5.

Turn ON the transmitter and receiver.  
The status LED should turn green on both. If they are blinking, see section on pairing in Operations chapter.

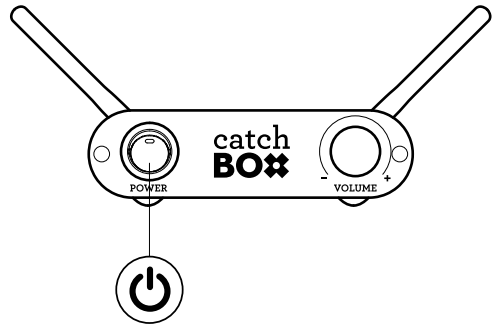
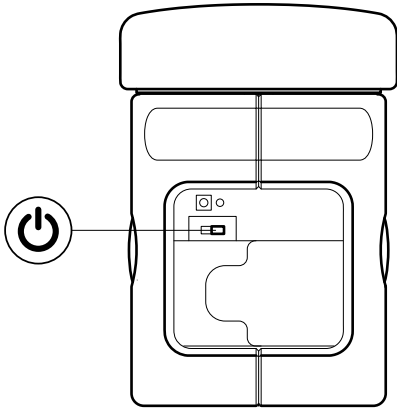

## 6.

Place the transmitter into the cover, making sure to align the magnetic locking mechanism so it is secure. Use the visual marks for guidance.

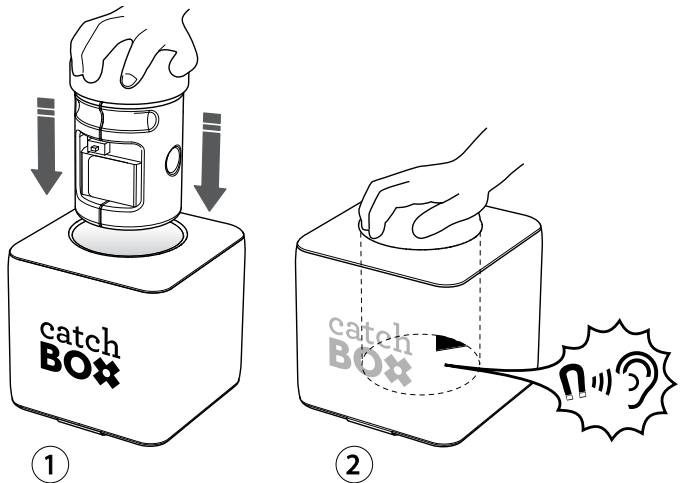
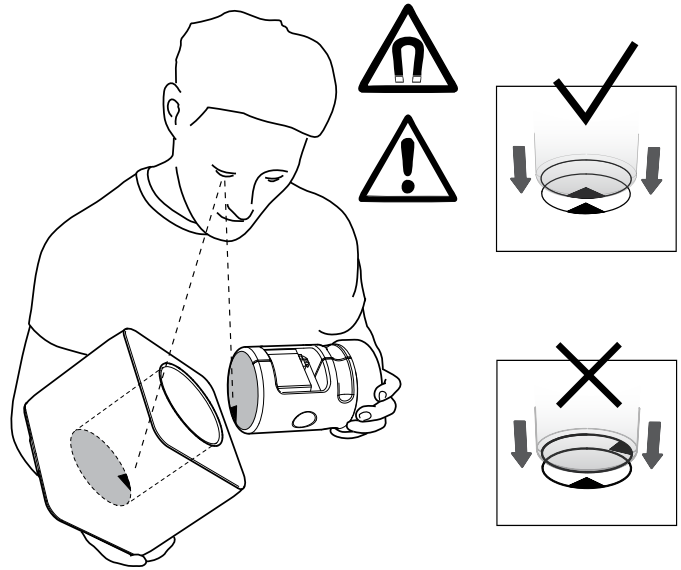

## 7.

Test the volume level by speaking into the microphone and adjusting it using the volume knob on the receiver.

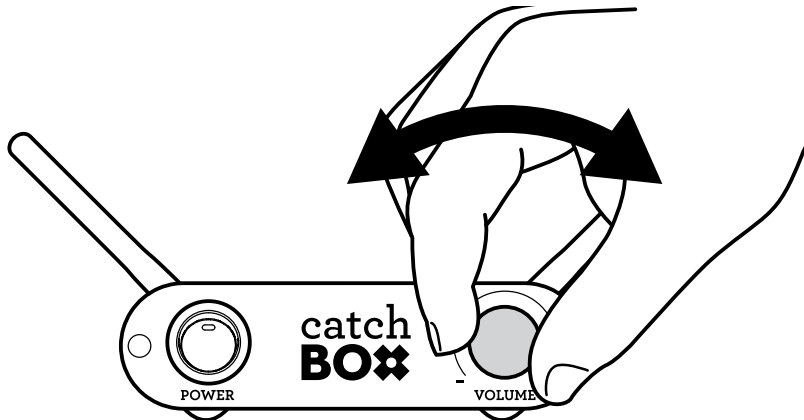

**! CAUTION !**

Avoid excessive volume. Do not exceed 70 dBa for airborne noise. Before turning on the device, make sure the volume knob is turned to zero (fully counterclockwise), to ensure that no unexpected loud noises appear when the device is turned on.

## Using the Catchbox

To throw the Catchbox microphone, find someone in the audience who wants to ask a question or make a comment. Make sure that the person and those around him or her are aware of the situation and are prepared to catch the microphone. Avoid throwing the Catchbox if there are fragile electronics or hot liquids nearby, as these might spill or be damaged from the throw. Short, underhand passes of up to 5 m / 16 ft distance are recommended. If someone farther away has a question, try to get the entire audience involved by having members pass the Catchbox short distances to the person who wants it. This is a great way to activate the crowd.

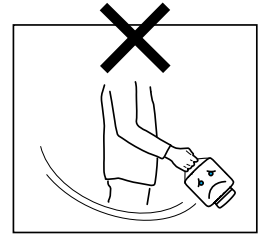
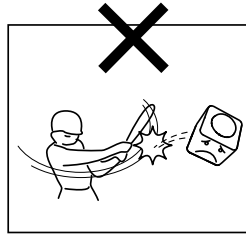
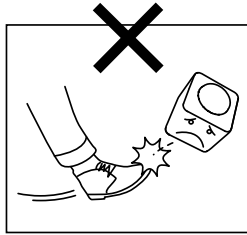
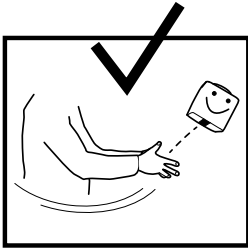

**! WARNING !**

Improper throwing and use of the device can lead to serious injury and/or property damage. Do not throw at peoples' heads and always make sure everyone is aware of the situation before throwing. Do not use in situations with fragile objects, dangerous liquids, or people susceptible to injury, like the very young or old. Do not throw long passes or hard passes. Do not swing or throw this product from its handle as this may cause the transmitter to detach from the cover.

### **Speaking into the Catchbox**

To use the Catchbox, simply speak into the foam cap located on top of the transmitter. It is advisable to inform audience members at what distance to speak into the Catchbox. A distance of 20 cm / 8 in is ideal. This will provide the clearest sound while not blocking the persons face who is speaking. Avoid using the Catchbox near loudspeakers as this can cause feedback.

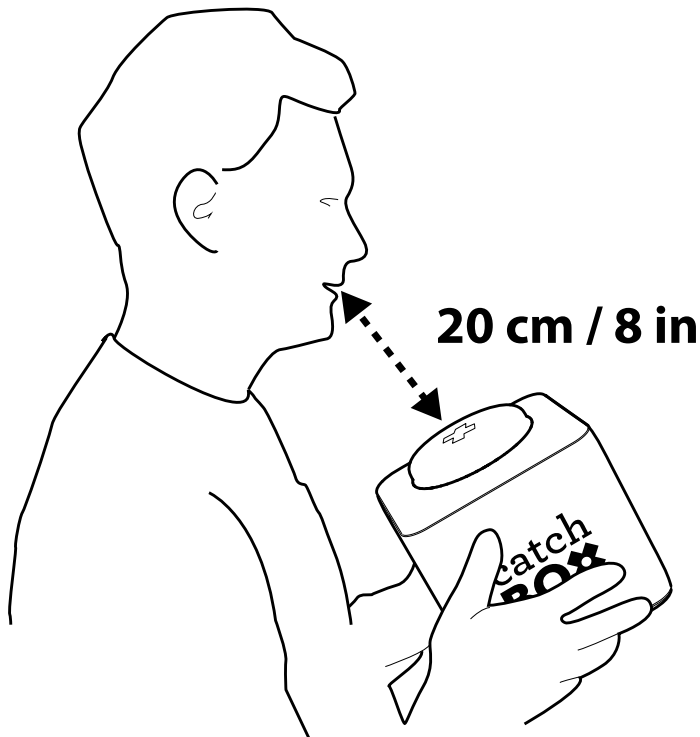

## 3 Product Description

---

### Overview

---

Catchbox 2.4 is the world's first wireless throwable microphone intended for both small and medium sized audiences of up to 100 people. The soft cube can be quickly passed from one audience member to the next in crowded spaces, making it an easy and fun way to get audience members to ask questions and make comments, whether it be in a lecture, a meeting, a workshop, or even a conference. Operating in the 2.4 GHz frequency band, the device is free to use without a license worldwide. Digital transmission, adaptive frequency hopping, and antenna diversity ensure a clear wireless audio transmission. The unique automute technology turns off the audio signal when the microphone is being thrown ensuring the system doesn't make any unwanted noises when being passed around.

### Key Features

- 2.4 GHz transmission for global, license-free use
- Digital signal ensures no audio distortion
- Adaptive frequency hopping and management
- Automute technology
- Diversity receiver with two antennas

### Included Components

- Catchbox 2.4 Transmitter
- Catchbox 2.4 Receiver
- Catchbox Cover
- Power supply (5V DC)
- Two antennas
- 6.3 mm audio cable
- 3.5 mm audio adapter
- RCA audio adapter



**! CAUTION !**

Do not attempt to modify this product or its accessories and use only accessories and attachments specified by the manufacturer.

## Proper Use and Working Environment

---

### **Safety First**

While the Catchbox 2.4 is a fun way to make events more engaging, improper use can lead to personal injury and/or property damage. Please understand that the manufacturer accepts no liability for damage or injuries arising from the misuse of this product. It is very important to read the safety instructions before using the product. Specifically, make sure that the transmitter is securely locked inside the foam cover before using the product. Also, do not throw long or hard passes, and avoid using the device in situations where there are fragile items, hot liquids, unsuspecting people, or people susceptible to injury. Also, avoid swinging or throwing the device from its handle as this may cause the locking mechanism to fail, releasing the transmitter and potentially causing injury.

### **Things to consider with magnets**

Since the product contains magnets, care should be taken when setting up the product for use. Avoid placing the transmitter on electrical devices, such as laptops, as these can be adversely affected or damaged from the magnetic field. People with pacemakers or other electrical implants should be especially careful, as these devices could stop working or switch into test mode if they come into direct contact with a strong magnet.

### **Limitations on event size**

The Catchbox 2.4 is designed for small to medium sized events of up to 100 people. These can range from lectures to conferences. The important thing to note is that because the product uses the 2.4 GHz Industrial, Scientific and Medical (ISM) frequency band, it may not work reliably in large events. This is because in such events there usually are many devices, such as mobile phones and laptops, that also work in the same frequency band.

## 2.4 GHz radio Spectrum Overview

---

The Catchbox 2.4 uses the 2.4 GHz ISM frequency band and is free to use without a license. While this is very convenient, it also creates limitations and drawbacks, mainly caused by the prevalence of other devices which also work in the same frequency band. To ensure flawless operation, the Catchbox 2.4 uses adaptive frequency hopping, antenna diversity, intelligent frequency management, and two way audio packet control and buffering. This said, by understanding the limitations of 2.4 GHz systems and knowing of ways to improve signal strength users can make sure that their device works as intended.

### Limitations of 2.4 GHz Systems

Devices that operate in the 2.4 GHz frequency band have a limited range, usually around 20-30 m / 65-100 ft in ideal working conditions. This, in turn, means the Catchbox 2.4 may not work in large events where there is a long distance between the transmitter and the receiver. 2.4 GHz frequency signals are also easily absorbed by walls, metallic materials, and human bodies. This means one should not place the Catchbox 2.4 Receiver into another room from the transmitter, or place it inside a cupboard, specifically a metal one. If there are many other devices that operate in the 2.4 GHz spectrum in the same space (WiFi and Bluetooth enabled devices, such as smartphones and laptops) dropouts may occur due to the frequency band being overcrowded. To avoid this, do not use the product in audiences with over 100 people, like large conferences or exhibitions.

### Improving signal strength

Users can improve the performance of the system through the following measures:

- Ensure that there are no objects or walls between the receiver and transmitter.
- Keep the distance between the transmitter and the receiver short.
- Position the antennas of the receiver in a 45 degree pattern, like the letter V.
- Do not place the receiver or transmitter near other 2.4 GHz devices, such as laptops or WiFi routers.
- Avoid heavy wireless network activities, like downloading movies, in the same space.



**! CAUTION !**

This product may cause interference to other products and devices operating in the 2.4 GHz ISM frequency band. These other devices can also interfere with the wireless transmission of the device, causing signal dropouts.



# 4 System Overview

---

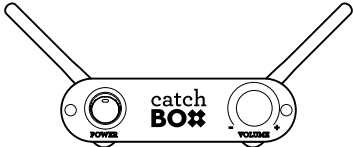

Catchbox 2.4  
Transmitter

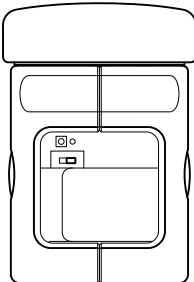

Catchbox 2.4  
Receiver

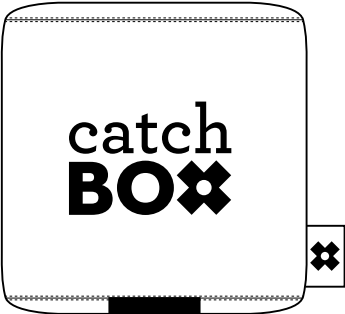

Catchbox  
Cover

### General Specifications

|   |   |
|---|---|
| Frequency band                            | 2.4 GHz ISM band                                  |
| Operation range                           | Up to 30 m / 100 ft (Line of Sight)               |
| Audio frequency response                  | 50-10000 Hz                                       |
| System latency<br>(audio in to audio out) | 20 ms   |
| Operating temperature range               | 0-50 degrees Celsius<br>32-122 degrees Fahrenheit |



# Catchbox 2.4 Transmitter

## Parts

- 1) Foam Cap
- 2) Pairing Button
- 3) Power Switch
- 4) Velcro Straps
- 5) Microphone element
- 6) Status LED
- 7) Battery Compartment
- 8) Magnetic Lock

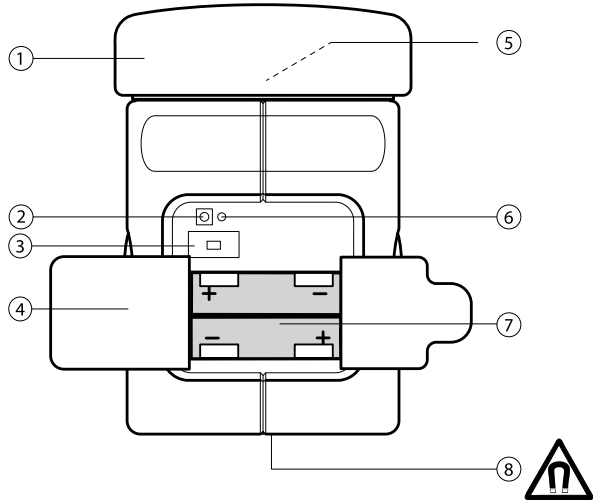

## Specifications

|                                |                                    |
|--------------------------------|------------------------------------|
| Weight                         | 165 g / 5.8 oz (with batteries)    |
| Dimensions (height x diameter) | 16 cm x 11.5 cm / 6.3 in x 4.5 in  |
| Battery type                   | 2xAA(LR6) alkaline                 |
| Battery life                   | >8 hours (with alkaline batteries) |

## Status LED Meaning

|                                     |   |
|-------------------------------------|---|
| Off                                 | The transmitter is not powered  |
| Blinking green (— — — — — )         | The transmitter is not paired to a receiver                               |
| Blinking green rapidly (- — — — — ) | The transmitter is attempting to pair to a receiver                       |
| Green on                            | The transmitter is on and is paired to a receiver                         |
| Red                                 | The transmitter is low on battery (less than 2 hours operating time left) |

## Catchbox Cover

---

### Parts

- 1) Opening for transmitter unit
- 2) Magnetic lock
- 3) Handle

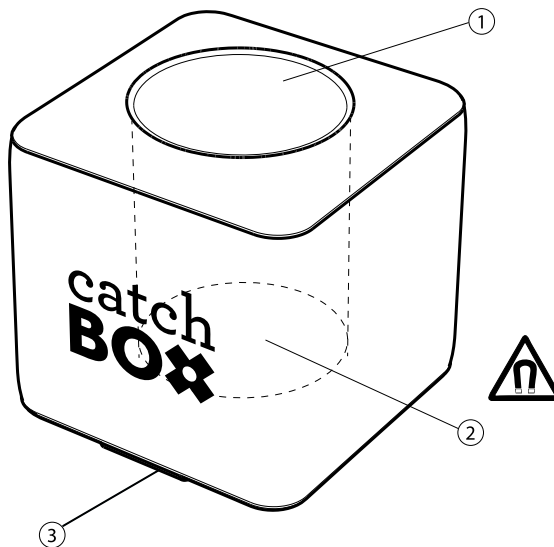

### Specifications

Weight

200 g / 7 oz

Dimensions

18 x 18 x 18 cm / 7 x 7 x 7 in

# Catchbox 2.4 Microphone Unit

---

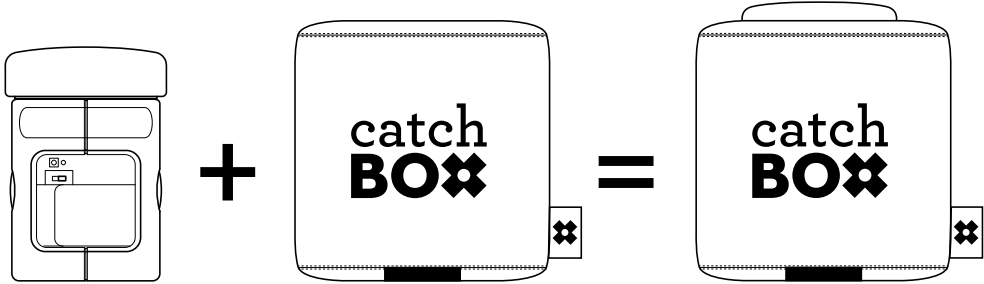

## Specifications

|            |                                |
|------------|--------------------------------|
| Weight     | 365 g / 12.8 oz                |
| Dimensions | 18 x 18 x 18 cm / 7 x 7 x 7 in |

## 5 Operations

---

### Attaching the Antennas to the Receiver

---

Connect the two antennas to the receiver unit by screwing them clockwise into the antenna ports located at the back. After the antennas have been connected, position them in a V shape to maximise their effectiveness.

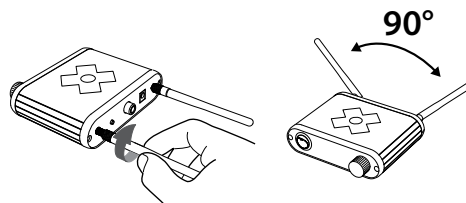

### Receiver Setup

---

Connect the power supply to the receiver and plug the cord into an AC power source. Connect the audio output located at the back of the receiver unit to a loudspeaker or sound mixer using the provided 6.3 mm / 1/4 in audio cable. Use the provided adapter pieces to match this cable to the input of your audio device.

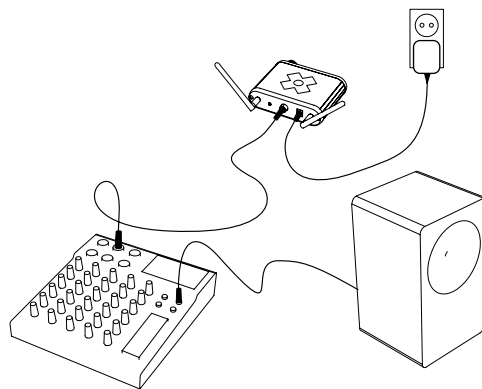

**! WARNING !**

The use of other antennas than those provided by the manufacturer is strictly prohibited.



**! CAUTION !**

Check that the AC input voltage stated on the included power supply matches the AC mains voltage available at your location. Using the power supply with a wrong AC voltage may cause damage to the product.

## Turning the Device on

---

Install two AA batteries into the transmitter, and secure them in place with the velcro strap provided. Turn on the transmitter and receiver. The status LED should turn green on both. If either is blinking, see the section on pairing.

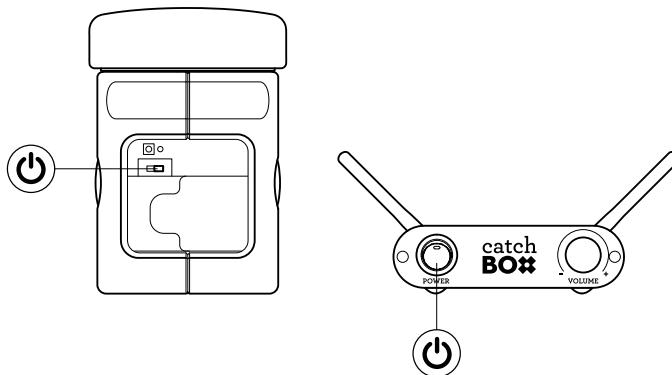
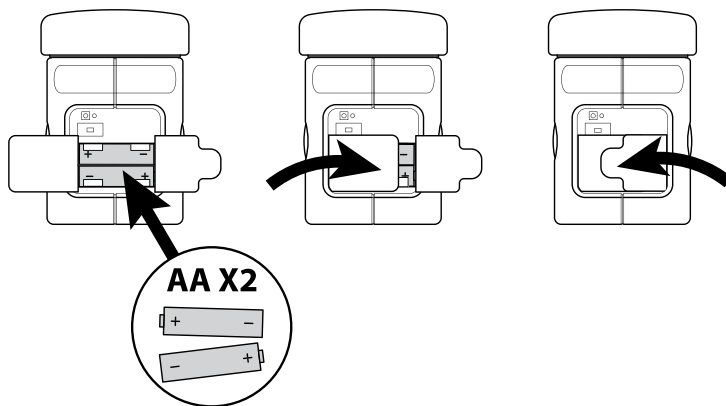

## Adjusting Volume

---

To adjust the volume, simply turn the volume knob located on the front of the receiver unit. Clockwise rotation increases volume while anti-clockwise rotation reduces it.

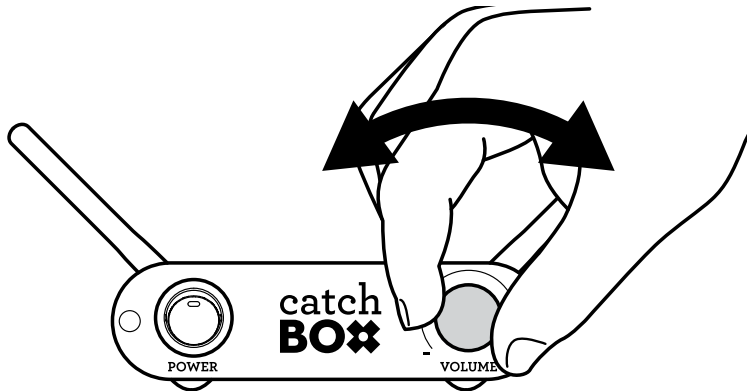

**! CAUTION !**

Avoid excessive volume. Do not exceed 70dBa for airborne noise. Before turning on the device, make sure the volume knob is turned to zero (fully counterclockwise), to ensure that no unexpected loud noises appear when the device is turned on.



## Locking the Transmitter to the Cover

To lock the transmitter unit into the cover, align the marks located at the bottom of the transmitter and bottom of the cover with each other. The locking mechanism is composed of two magnets that attract each other when correctly aligned. To test whether the locking has been successful, one can try to pull on the transmitter and attempt to remove it with a vertical force. If it does not come out with significant force, the magnets are correctly aligned. To remove the transmitter, simply twist it 90 degrees and pull. This motion will misalign the magnets and allow for easy removal of the transmitter.

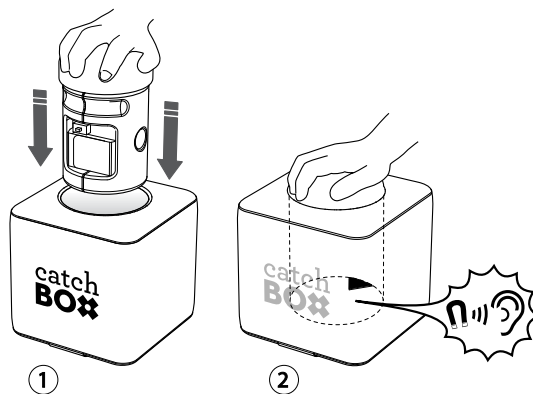
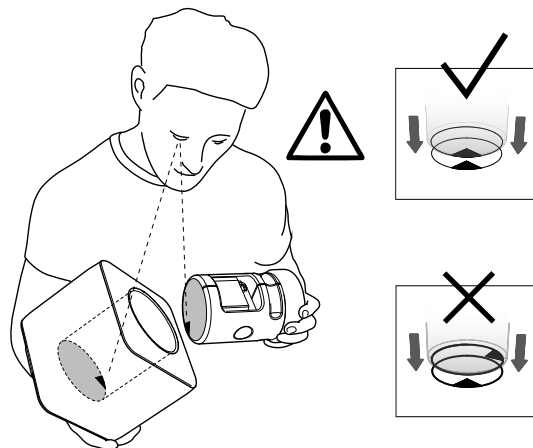

### **! WARNING !**

Always properly lock the transmitter unit, with the attached foam cap, into the cover before use. Improperly locking the transmitter, or a failed locking mechanism, will result in the transmitter unit coming out during use, potentially leading to serious injury and/or property damage.

## Opening the Catchbox

---

To remove the transmitter, simply twist it 90 degrees and pull upward. This motion will misalign the magnets and allow for easy removal of the transmitter unit.

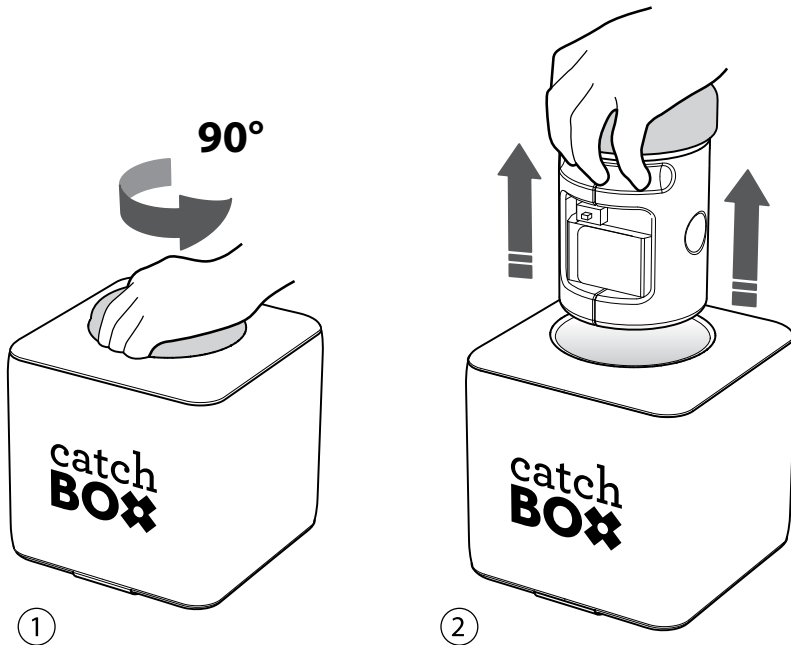

## Pairing the Transmitter and Receiver

In order to function properly, the Catchbox 2.4 Transmitter unit needs to be paired with a Catchbox 2.4 Receiver unit. To pair the two units, follow these steps:

1. Turn on both devices and place them within 2 m / 6 ft of each other.
2. Press the Pairing button on either of the devices (transmitter or receiver). The Status LED on that device will start blinking rapidly for a period of 20 seconds.
3. Within the 20 second period, press the pairing button on the other device. Both devices are paired if both status LEDs stop blinking and are On. If they are still blinking, pairing was not successful, and you should try again.

*Note: It is only possible to pair one transmitter unit to a single receiver unit. Devices will stay paired after turning off the power.*

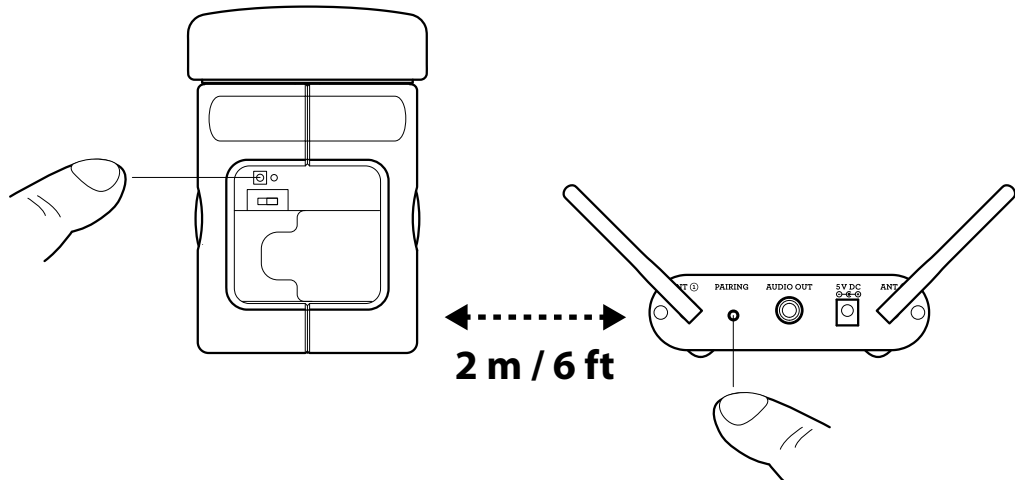

## Connecting to an Audio Device

---

You can connect the Catchbox 2.4 Receiver to the audio inputs of devices such as audio mixers, stereo systems and laptops. First, connect the 6.3 mm audio cable to the receiver's audio output port. Afterwards, use the different adapter pieces provided with the product to connect the audio cable to the audio input of your device. The most common inputs are:

- 1) RCA (common in stereos)
- 2) 3.5 mm ( $\frac{1}{8}$  in) (common in computers)
- 3) 6.3 mm ( $\frac{1}{4}$  in) (common in audio mixers)

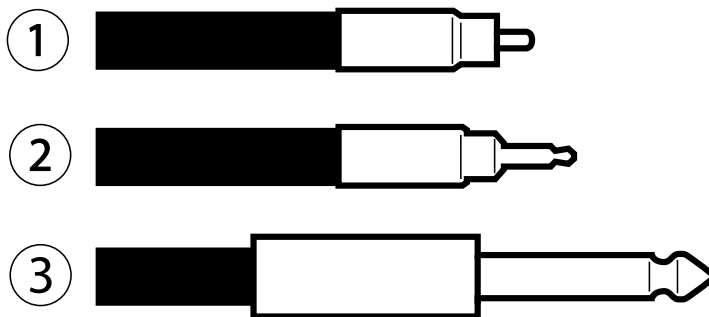

**! CAUTION !**

Please check the wiring of the audio connections before attaching the cables. Catchbox receiver's 6.3 mm ( $\frac{1}{4}$ in) TRS audio out jack pinout is: Tip=audio, Ring=no audio, Sleeve=ground. It is compatible with most audio device inputs. Connecting parts with incompatible pinouts may damage both devices.

# 7 Troubleshooting

---

| <b>Problem</b>                          | <b>Possible Cause</b>  | <b>Solution</b>  |
|---|--|--|
| <b>No sound</b>                         | <ol style="list-style-type: none"><li>1) Transmitter and receiver are not paired. See if the status LED is blinking, which indicates unpaired state.</li><li>2) The receiver or transmitter is off, indicated by no light on either units' status LEDs.</li><li>3) Transmitter batteries are out of power or placed in the wrong polarity.</li></ol> | <ol style="list-style-type: none"><li>1) Pair the transmitter to the receiver unit. See section on pairing in the Operations chapter.</li><li>2) Plug the receiver into a wall socket. Place batteries in the transmitter. Make sure both devices are turned on.</li><li>3) Check the battery polarity or replace the batteries with new ones.</li></ol>   |
| <b>Audio signal dropouts or breaks</b>  | <ol style="list-style-type: none"><li>1) Transmitter and receiver are too far away from each other or there are obstacles in the way.</li><li>2) Receiver antennas are not properly attached or positioned.</li><li>3) Too much interfering wireless traffic.</li></ol>  | <ol style="list-style-type: none"><li>1) Place the transmitter and receiver closer to increase signal strength. Place the receiver unit in clear view of the transmitter.</li><li>2) Attach the two antennas to the back of the receiver, positioning them in a V shape.</li><li>3) Reduce the amount of wireless devices in the room, either by turning off wireless routers or limiting the use of 2.4 GHz devices, such as mobile phones and laptops.</li></ol> |
| <b>Distorted sound</b>                  | <ol style="list-style-type: none"><li>1) Audio cable or adapter piece is broken or not properly attached</li><li>2) Volume is too high</li></ol>   | <ol style="list-style-type: none"><li>1) Check the audio cable connection and adapter piece. If problem persists, replace the cable and/or adapter.</li><li>2) Reduce the output volume at the receiver by using the volume knob.</li></ol>  |
| <b>Transmitter falling out of cover</b> | <ol style="list-style-type: none"><li>1) The magnets are misaligned.</li><li>2) Magnetic lock has been damaged or magnets have lost strength.</li></ol>  | <ol style="list-style-type: none"><li>1) Align the magnet by twisting the transmitter inside the cover.</li><li>2) Get the product serviced.</li></ol>   |
| <b>Audio feedback</b>                   | <ol style="list-style-type: none"><li>1) Catchbox microphone is situated too close to the loudspeaker system</li></ol>   | <ol style="list-style-type: none"><li>2) Move Catchbox microphone away from the loudspeakers.</li></ol>  |

For more technical assistance, contact us by email or visit our Youtube channel via our website:  
info@getcatchbox.com / www.getcatchbox.com

## 8 Maintenance, Storage, and Disposal

---

Proper maintenance and storage of the Catchbox 2.4 wireless system will help ensure the product remains operational and safe to use. Improper maintenance or storage, in turn, can lead to equipment failure which can cause serious injury during use. Do not attempt to repair the unit yourself. The equipment should be opened, serviced, and repaired by authorized personnel only. Always refer to the user manual for proper maintenance, storage, and disposal instructions and do not throw away the user manual. Always keep it near the product for reference by other users.

### Cleaning

To clean the equipment, use a moistened (not wet) cloth only. Be sure to disconnect the equipment from the power outlet before cleaning. To clean the outer cover, first remove the transmitter unit from the inside. Only use dry cleaners and do not place the outer cover in a washing machine. Always remember to inform cleaners that the device contains a magnet and should not be treated in temperatures in excess of 50 degrees Celsius or 122 degrees Fahrenheit or near equipment sensitive to strong magnetic fields.

### Storage

Magnets produce a far-reaching, strong magnetic field. Keep magnets away from devices and objects that could be damaged by strong magnetic fields, like laptops and other electrical equipment. Operating or storing this product in temperatures above 50 degrees Celsius or 122 degrees Fahrenheit will cause the locking mechanism to fail permanently. This, in turn, will cause the transmitter capsule to fall out of the cover during use, potentially leading to personal injury or property damage. Do not place the equipment near heat sources such as heating ducts or radiators and do not expose it to direct sunlight, excessive dust, moisture, rain, mechanical vibrations, or shock. Do not use or store near water. If the equipment comes into contact with a liquid, shut down the sound system and disconnect the power cable from the power outlet immediately.

### Disposal

To dispose of a broken or defective unit, send the unit back to the manufacturer or consult your local waste management professional. Be sure to dispose of dead batteries as required by local waste disposal rules. Never throw batteries into a fire or a garbage bin.

# 9 Certification

---

**The Catchbox 2.4 wireless system consists of:**

- Catchbox 2.4 Transmitter (Model #: CB24TX001)
- Catchbox 2.4 Receiver (Model #: CB24RX001)



|   |  |
|---|--|
| <p><b>Catchbox 2.4 Transmitter</b><br/>         Product meets the essential requirements of the European R&amp;TTE Directive 1999/5/EC and is found to comply with the following standards:</p> <p>EN 300328 v1.8.1<br/>         EN 301489-1 v1.9.2<br/>         EN 301489-17 v2.2.1<br/>         EN 60950-1</p> <p>Certified under FCC Part 15.<br/>         FCC ID: 2AB78CB24TX001</p> <p>Certified under IC in Canada under RSS-210 and RSS-GEN.<br/>         IC: 11942A-CB24TX001</p> | <p><b>Catchbox 2.4 Receiver</b><br/>         Product meets the essential requirements of the European R&amp;TTE Directive 1999/5/EC and is found to comply with the following standards:</p> <p>EN 300328 v1.8.1<br/>         EN 301489-1 v1.9.2<br/>         EN 301489-17 v2.2.1<br/>         EN 60950-1</p> <p>Certified under FCC Part 15.<br/>         FCC ID: 2AB78CB24RX001</p> <p>Certified under IC in Canada under RSS-210 and RSS-GEN.<br/>         IC: 11942A-CB24RX001</p> |
|---|--|

This device complies with part 15 of the FCC Rules. Operation is subject to the following two conditions: (1) This device may not cause harmful interference, and (2) this device must accept any interference received, including interference that may cause undesired operation.

## **Information to the user**

This equipment has been tested and found to comply with the limits for a Class B digital device, pursuant to Part 15 of the FCC Rules. These limits are designed to provide reasonable protection against harmful interference in a residential installation. This equipment generates, uses, and can radiate radio frequency energy and, if not installed and used in accordance with the instructions, may cause harmful interference to radio communications. However, there is no guarantee that interference will not occur in a particular installation. If this equipment does cause harmful interference to radio or television reception, which can be determined by turning the equipment off and on, the user is encouraged to try to correct the interference by one or more of the following measures:

- Reorient or relocate the receiving antenna.
- Increase the separation between the equipment and the receiver.
- Connect the equipment to an outlet on a circuit different from that to which the receiver is connected.
- Consult the dealer or an experienced radio/TV technician for help.

Changes or modifications to the equipment not expressly approved by manufacturer can void the user's authority to operate the equipment.

## **Industry Canada Compliance**

This device complies with Industry Canada licence-exempt RSS standard(s).

Operation is subject to the following two conditions: (1) this device may not cause interference, and (2) this device must accept any interference, including interference that may cause undesired operation of the device.

Le présent appareil est conforme aux CNR d'Industrie Canada applicables aux appareils radio exempts de licence. L'exploitation est autorisée aux deux conditions suivantes : (1) l'appareil ne doit pas produire de brouillage, et (2) l'utilisateur de l'appareil doit accepter tout brouillage radioélectrique subi, même si le brouillage est susceptible d'en compromettre le fonctionnement.

The installer of this radio equipment must ensure that the antenna is located or pointed such that it does not emit RF field in excess of Health Canada limits for the general population; consult Safety Code 6, obtainable from Health Canada's website [www.hc-sc.gc.ca/rpb](http://www.hc-sc.gc.ca/rpb).





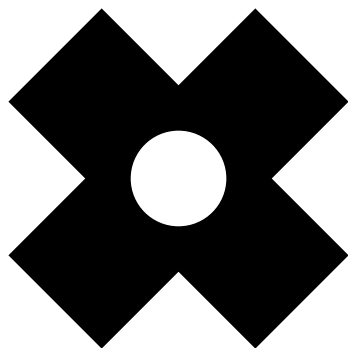

[www.getcatchbox.com](http://www.getcatchbox.com)

CE FC